

Multi-Function Transmitter for Pressure-Temperature with internal Temperature Sensor

AE-TPSI SERIE

Main features

- Pressure measuring ranges 0...1 bar to 0...1.000 bar
- Temperature measuring range -50°C to +150°C
- Output signals for pressure 0...10 V, 0.5...4.5 V
for temperature 0.25...4.75 V
- No internal transmission media
- Precision class 0.5 %
- Highly reliable
- Protection class IP67

Applications

- Hydraulics
- Pneumatics
- Air conditioning and refrigeration (HVAC) heating systems
- Plant and automation engineering

Description

This intelligent solution combines **two transmitters** which are capable of measuring **pressure and temperature** at the same time and **independently**.

This multi-functional transmitter has excellent characteristics for its stainless steel membrane and semi-conductor thin-film technology. The stainless steel membrane is absolutely vacuum-tight, extremely burst-proof and applicable with all standard media used in hydraulics, pneumatics, etc. as far as they are compatible with stainless steel. Its robust design guarantees high reliability also in rugged environments.

The temperature is measured by means of an internal temperature sensor.



Multi-Function Transmitter for Pressure-Temperature With Internal Temperature Sensor

Specification

Pressure range

Measuring range*	p [bar]	1,0	1,6	2,0	2,5	4,0	6,0	10,0	16,0
Overload pressure	p [bar]	6	6	6	10	10	20	20	40
Burst pressure	p [bar]	9	9	9	15	15	30	30	60
Measuring range*	p [bar]	20	25	40	60	100	160	200	
Overload pressure	p [bar]	40	100	100	200	200	400	400	
Burst pressure	p [bar]	60	150	150	300	300	600	600	
Measuring range*	p [bar]	250	400	600	1000				
Overload pressure	p [bar]	750	750	840	1200				
Burst pressure	p [bar]	1000	1000	1050	1500				

Electrical parameter

		signal for pressure		U_s [V _{DC}]	R_L [k Ω]	R_A [Ω]
Output signal * and maximum acceptable burden R_A	R_A in Ohm	0...10 V _{DC}	(3-wire) ratiometric	12...32	> 5,0	acc. to $R_A = < (U_s - 10V) / 0,02 A$
		0,5...4,5 V _{DC}	ratiometric	5 \pm 10%	> 4,7	
		signal for temperature				
		0,25...4,75 V _{DC}	ratiometric	5 \pm 10%	> 4,7	
Response time * (10-90%)		for pressure		for temperature		
	t [ms]	< 1		120		
Withstand voltage	U [V _{DC}]	350				

Accuracy

		pressure / temperature	
Accuracy @RT	% of the range	$\leq 0,50^{**}$	option $\leq 0,25$ (only valid for pressure)
	BFSL	$\leq 0,125$	
Non-linearity	% of the range	$\leq 0,15$	** incl. nonlinearity, hysteresis, repeatability, zero-offset- and final-offset
Repeatability	% of the range	$\leq 0,10$	(acc. to IEC 61298-2)
Stability/year	% of the range	$\leq 0,10$	

Acceptable temperature ranges

		pressure / temperature	
Measuring medium, always	T [°C]	-40...125	
Measuring medium, 15 min	T [°C]	-50...150	
Ambience	T [°C]	-40...105	
Storage	T [°C]	-40...125	
Compensated range*	T [°C]	-20...85	

Temperature coefficient within the compensated range

Mean TC offset	% of the range	$\leq 0,15 / 10K$
Mean TC range	% of the range	$\leq 0,15 / 10K$
Total error	% of the range	-40°C 2,00%
	% of the range	105°C 2,00%

Mechanical parameter

Parts in contact with the measuring medium*	stainless steel		
Housing*	stainless steel		
Shock resistance	g	1000	acc. to IEC 68-2-32
Vibration resistance	g	20	acc. to IEC 68-2-6 and IEC 68-2-36
Mass	m [g]	80-120	depending on design
CE - conformity	EC Directive 89/336/EWG		
IP system of protection	The IP system of protection as specified in the data sheets generally applies, with their mating plug connected. Relative pressure transmitters usually require a ventilated mating plug and/or cable to allow for pressure compensation. From a pressure range of 60 bar, a ventilated mating plug and/or cable is not necessarily required.		
* others upon request			

Configuration -examples-

TPSI with M12x1 (S763)



M16x075
(S723)



M12x1
(S763)

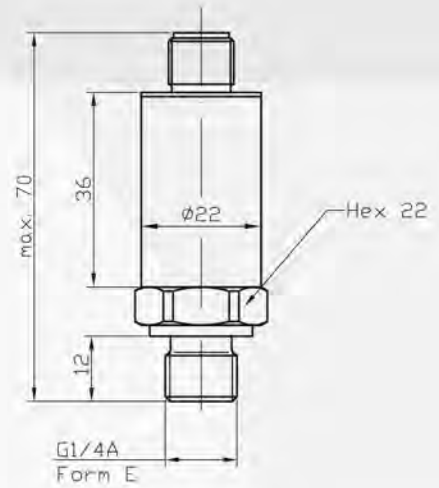

Connectors*

male socket
M12x1
(S 763)

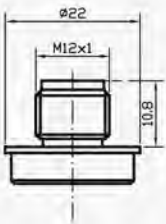

male socket
M16x0,75
(S 7 23)

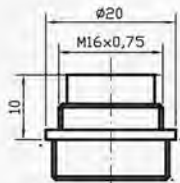

cable output
plastic

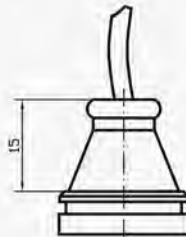

Pressure Connections*

G 1/4 A;
DIN 3852; Form E

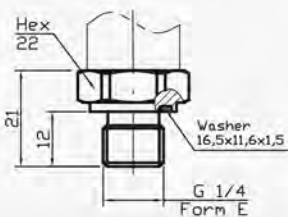

G 1/4 B

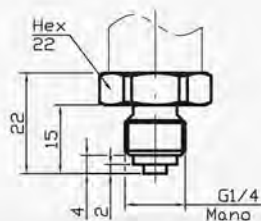

1/4 NPT

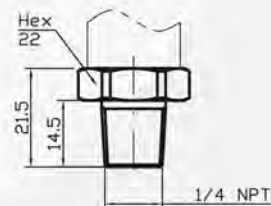

* custom-made adjustments acc. to pressure connections and connecting options are possible

AE-TPSI SERIE

Multi-Function Transmitter for Pressure-Temperature with internal Temperature Sensor

Electrical Connections*

male socket
M16x0,75
(S 723,
5 pin)

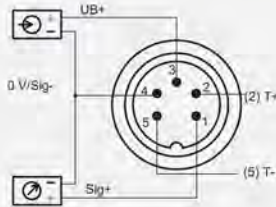

male socket
M16x0,75
(S 723,
8 pin)

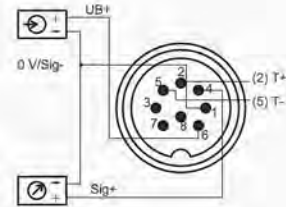

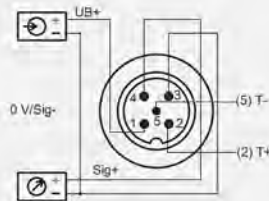

male socket
M12x1
(S 763,
5 pin)



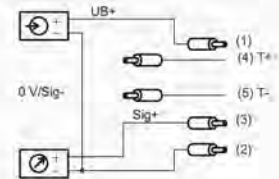



cable
output



Legend

 power supply
 load

(1)  red
(2)  black
(3)  white
(4)  green
(5)  white / blue

* custom-made adjustments acc. to pressure connections and connecting options are possible

Product line

DS4	Electronic Pressure Switch	SMC	Pressure Transmitter with CANopen Interface
DPSX9I	Intrinsically Safe Electronic Pressure Switch for Current	SME	Pressure Transmitter in Miniature Design
DPSX9U	Intrinsically Safe Electronic Pressure Switch for Voltage	SMF	Pressure Transmitter with Flush Diaphragm
PS1	Level Sensor	SMH	High Pressure Transmitter
PSX2	Intrinsically Safe Level Sensor	SML	Pressure Transmitter for Industrial Application
SHP	High Precision Pressure Transmitter	SMO	Pressure Transmitter in Mobile Hydraulics
SIS	Low Pressure Transmitter in Short and Compact Design	SMS	OEM Pressure Transmitter for Hydraulics and Pneumatics
SIL	Low Pressure Transmitter for Industrial Application	SMX/SMX2	Intrinsically Safe Pressure Transmitter for Industrial Application
SKE	High Temperature Pressure Transmitter with Detached Electronics	TPS	Multi-Function Transmitter for Pressure and Temperature
SKL	High Temperature Pressure Transmitter with Cooling Fins		

