



T24-Safe/i

mantracourt

Wireless Strain Bridge Transmitter Module for Fast Measurements



Introduction

The T24-Saf transmitter connects to strain bridge transducers such as load cells, torque sensors, strain gauges and pressure modules and forms part of the T24 modular telemetry system. The data transmitted by the T24-Saf can be received by multiple T24 receivers that include handheld readers, analogue outputs and computer interfaces.

T24 transmitters have been designed for battery operation and support an ultra low-power sleep mode whilst offering class leading wireless coverage and range. A choice of enclosures enabling battery connection, field connectivity and environmental sealing up to IP67 ensure these modules provide a flexible solution to your wireless sensor requirements.

The T24-Saf is a 2000 samples per second (fixed) version of the T24-SA for high speed monitoring. T24-Saf provides 5 V excitation to drive transducer loads down to 85 ohms. This transmitter is highly accurate, low noise and outputs in nV/V giving quality measurements from a wide range of strain bridge transducers.

Product Features

- Ultra-fast update rate of 2000 per second
- Wireless range up to 800 m (2,600 ft)
- Low power mode for long battery life
- Miniature PCB for OEM integration
- Free Visualisation software

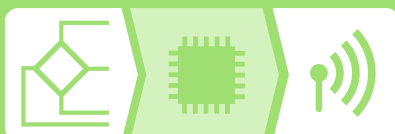

T24 System Overview



T24 Wireless Telemetry Sensor System is a modular wireless solution for industrial sensor applications.

High accuracy, high quality measurement is interfaced with simple yet powerful configuration and monitoring software.

Specifications

Measurement Specifications

Strain gauge excitation system	4 wire
Strain gauge excitation	5 Vdc
Strain gauge resistance (min)	85 Ω
Strain gauge sensitivity (max)	3.2 mV/V
Offset temperature stability (max)	4 ppm/°C
Gain temperature stability (max)	5 ppm/°C
Non linearity before linearization (max)	25 ppm of FR
Internal resolution/Bits	16,000,000 / 24
Noise free resolution/Bits at 1 sample per second	8,000/ 13
Transmission rate	2000Hz

Battery Life

Based on transmitting results at 3 per second , 350R strain bridge	
Pair AA cells constantly on	30 hours
Pair AA cells 12 sessions per day of 5 mins	30 days
Pair DD cells constantly on	5.5 days
Pair DD cells 12 sessions per day of 5 mins	4.5 months

Power Supply

ACMi and OEM module	2.1 to 3.6 Vdc
ACM	5 to 18 Vdc

Radio

Radio type	Licence exempt transceiver
Radio frequency	2.4 GHz
Transmit power	10 mW
Range	Up to 800 m

Environmental

Operating temperature range	-20 to 55 °C
Storage temperature range (no batteries)	-40 to 85 °C
Maximum humidity	95% non-condensing
IP rating (ACM and ACMi)	IP67/Nema4

Mechanical

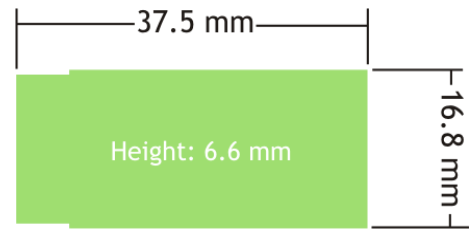

Electrical

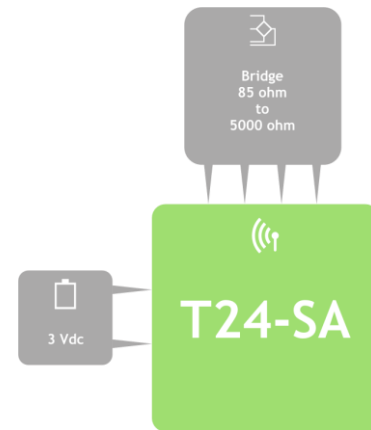

Order Codes

T24-Safe

Wireless strain bridge (fast) OEM transmitter module for external antenna

T24-Safi

Wireless strain bridge (fast) OEM transmitter module with antenna

T24-ACM-SAf

Wireless strain bridge (fast) transmitter module in IP67 enclosure supporting two D batteries or external power supply.

T24-ACMi-SAf

Wireless strain bridge (fast) transmitter module in IP67 enclosure for two AA batteries

T24-ACMm-SAf

Wireless strain bridge (fast) transmitter module in miniature IP50 enclosure

Mantracourt Electronics Ltd
The Drive, Farringdon
Exeter, Devon, UK
EX5 2JB

Tel: +44 (0)1395 232020
Email: sales@mantracourt.com
mantracourt.com



1 SENSOR
INPUT

3 HOUSING
OPTIONS

Every T24 transmitter module can be ordered in **one of three** IP rated enclosures.

To aid your work, they provide:

- Power Supply
- Water & Dust Protection
- Field Connectivity
- Ready-Made Mounting Solution

ACM









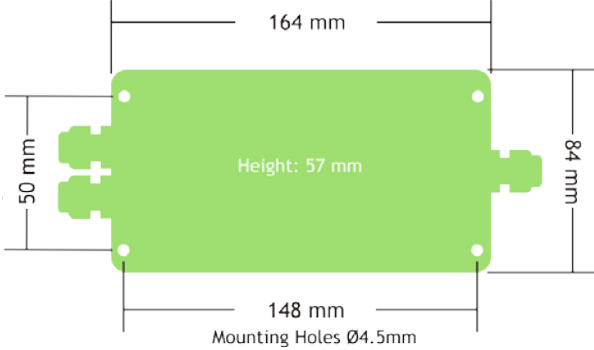
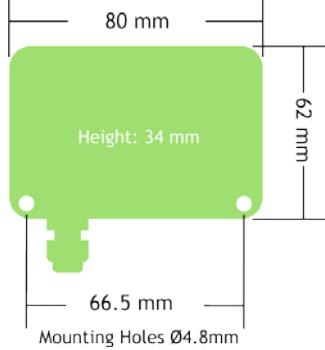
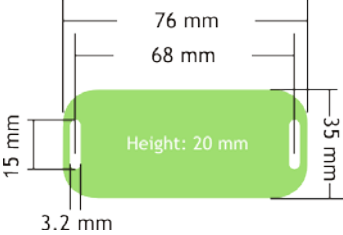

ACMi



ACMm



							
Enclosure	ACM	ACMi	ACMm				
Wireless range / m	800 m (2,600 ft)		500 m (1,600 ft)				
Power supply	3-18 Vdc or 2xD cell	3 Vdc (2xAA)	3 Vdc (2xAAA with BB1)				
Battery life at 1 transmission per second*	1 year	5 months	2 months				
Antenna	ANTA	ANTA	PCB Printed				
Radio frequency	2.4 GHz						
Operating temperature /°C	-20 to +55	-20 to +55	-40 to +80				
Environmental protection	IP67		IP50				
Module size / mm	164 x 84 x 57	80 x 62 x 34	76 x 35 x 20				
Software & configuration	T24 Toolkit & T24LOG100						
Input modules (determined by order code)	 SA Strain  SA f Strain(2kHz)  IA Current  VA Voltage  TA Temperature  PA Pulse  RA Potentiometer						
Order codes:	T24-ACM-SA T24-ACMi-SA T24-ACMm-SA	T24-ACM-SAf T24-ACMi-Saf T24-ACMm-SAf	T24-ACM-IA T24-ACMi-IA T24-ACMm-IA	T24-ACM-VA T24-ACMi-VA T24-ACMm-VA	T24-ACM-TA T24-ACMi-TA T24-ACMm-TA	T24-ACM-SA T24-ACMi-SA T24-ACMm-SA	T24-ACM-RA T24-ACMi-RA T24-ACMm-RA

*For more information please refer to the T24 Acquisition Module Battery Life Calculator