

Pressure Transmitter

ATM/F - Hygienic Pressure Transmitter



Customer benefits

- Welded and compact design for washdowns without residuals
- Surface roughness of flush process connection $Ra \leq 0.4$ for highest hygienic standards
- Demountable electrical connector option allow adjustment of zero and span setting in the field
- Fast customization thanks to modular product design
- Short response times suitable for dynamic pressure measurements

Version: 04.05.2016

Technical Specifications

Pressure measuring range (bar)

	0.1 ... 0.5	> 0.5 ... 2	> 2 ... 25
Overpressure	3 bar	3 x FS (≥ 3 bar)	3 x FS
Burst pressure, (1)	> 200 bar	> 200 bar	> 200 bar
Accuracy, (2), (± % FS)	≤ 0.5 / ≤ 0.25	≤ 0.5 / ≤ 0.25 / ≤ 0.1	≤ 0.5 / ≤ 0.25 / ≤ 0.1
Thermal shift, (± % FS/°C)			
Zero point 0 ... 70°C	≤ 0.06	≤ 0.03	≤ 0.015
Zero point -25 ... 85°C	≤ 0.08	≤ 0.04	≤ 0.02
Span 0 ... 70°C	≤ 0.015	≤ 0.015	≤ 0.015
Span -25 ... 85°C	≤ 0.02	≤ 0.02	≤ 0.02
Long term stability, (3)	< 0.5% FS / < 4 mbar	< 0.2% FS / < 4 mbar	< 0.1% FS / < 0.2% FS

(1) Transducer

(2) Zero based accuracy according to DIN-16086, incl. hysteresis and repeatability at ambient temperature

(3) 1 year (typ. / max.)

Temperature range

Operating temperature	-25 ... 85°C
Process temperatur	-25 ... 100°C
Storage temperatur	-25 ... 85°C

Electrical specifications

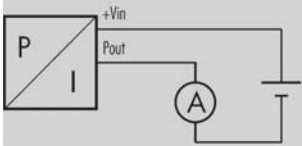
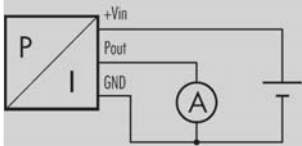
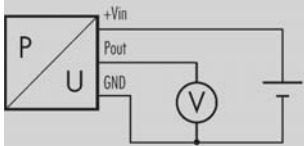
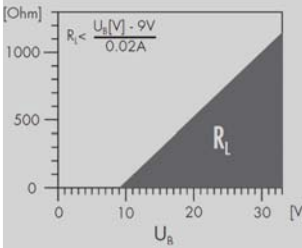
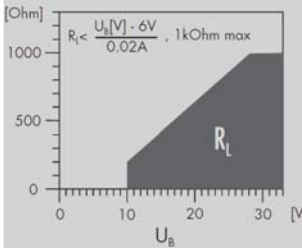
	4 ... 20 mA	0 ... 20 mA	0 ... 5 V / 0 ... 10 V
Power supply	10 ... 33 VDC	9 ... 33 VDC	15 ... 30 VDC
Supply influence	< 0.1% FS	< 0.1% FS	< 0.1% FS
Current consumption			3 mA
Circuit diagram			
Load resistance			$R_L > 10k\Omega$
Load influence	< 0.1% FS	< 0.1% FS	< 0.1% FS

Qualifications

	Description	Level	Typical interferences
EN 61000-4-2	Electrostatic discharge	4 kV contact 8 kV air	
EN 61000-4-3	Irradiated RF	10V/m (0.08 ... 1 GHz)	Radio sets, wireless phones
EN 61000-4-4	Transients (burst)	2 kV	Motors, valves
EN 61000-4-5, (1)	Surge	10 kA (8 / 20 µs), (1)	Overvoltage
EN 61000-4-6	Conducted RF	10 V (0.15...80 MHz)	Frequency converters

(1) Only with optional overvoltage protection

Physical specifications

Materials	
Transducer	Stainless steel (316L / 1.4435)
Housing	Stainless steel (316L / 1.4404)
Seals	Viton
Surface roughness of the flush (Ra)	0.4 - 0.8

Accessories

Overview

10.00.0091	Accessories overview
HART001	Cable Socket Connector DIN43650

Additional documents

Operating and safety instructions

	Article number
10.88.0092	DMM029

Ordering information

		X. XXXX.	XXXX.	XX.	XXX
Type					
	ATM/F	25			
Pressure type					
	Gauge	1			
	Absolute pressure (vacuum)	2			
	Sealed gauge	3			
Pressure measuring range					
	100 mbar ... 25 bar	XX			
Process connection					
	Milk flange DN 25 - DIN-11851 (Fig. 1), (1)	30			
	Milk flange DN 40 - DIN-11851 (Fig. 2), (1)	31			
	Milk flange DN 50 - DIN-11851 (1)	32			
	Clamp 1", DN 25 (Fig. 3)	40			
	Clamp 1 1/2", DN 25 (Fig. 3)	41			
	DIN flange DN 25	45			
	DIN flange DN 40	46			
	DIN-flange DN 50	47			
	Customized	99			
Electrical connection					
	DIN-43650, with metal threaded part, demountable, IP 65 (Fig. 10), (2)		01		
	M16 (Binder 723), 5 pins, (2)		03		
	M16 (Binder 723), 5 pins, demountable, IP 67 (Fig. 12), (2)		43		
	MIL C26482, 10-6, IP 40 (Fig. 13), (2)		06		
	M12 (Lumberg RSF4), 4 pins (Fig. 15), (2)		07		
	Customized		99		
Output signal					
	4 ... 20 mA		05		
	0 ... 20 mA		00		
	0 ... 5 VDC		46		
	0 ... 10 VDC		47		
	4 ... 20 mA with overvoltage protection		08		
	0 ... 10 VDC with overvoltage protection		49		
	Customized		99		
Accuracy					
	$\leq \pm 0.5$ % FS			0	
	$\leq \pm 0.25$ % FS			1	
	$\leq \pm 0.1$ % FS			2	
Temperature range					
	0 ... 70°C compensated (allowed process temperature: -25 ... 100°C)			0	
	-25 ... 85°C compensated (allowed process temperature: -25 ... 100°C)			1	
	-25 ... 85°C compensated (allowed process temperature: -25 ... 100°C) with cooling fins			2	
	Customized			9	
Option 1					
	Special oil filling: Anderol Food (for food applications)				G
	Special oil filling: AS100 (suitable in media temp. -55 ... 150°C)				J
	Special oil filling: PAO4 (silicone free)				Q

Option 2					
	Electronics packed in gel: Gauge pressure				C
	Electronics packed in gel: Absolute pressure				D
Option 3					
	Seals: Viton (standard)				U

(1) Nut included

(2) Cable socket connector not included

Technical drawings

Pressure connection

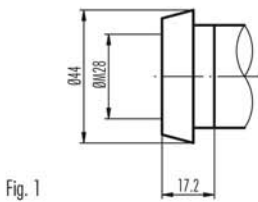

Fig. 1

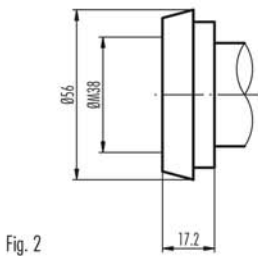

Fig. 2

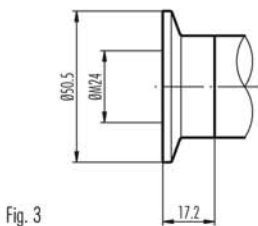
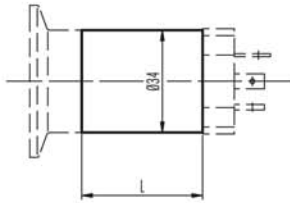

Fig. 3

Dimensions

Version for media temperature up to 100°C



L = 90 mm for version with surge (lightning) protection
L = 40 mm for all other versions

Version for media temperature >100°C up to 150°C

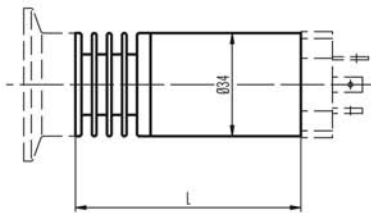

L = 125 mm for version with surge (lightning) protection
L = 75 mm for all other versions

Electrical connections

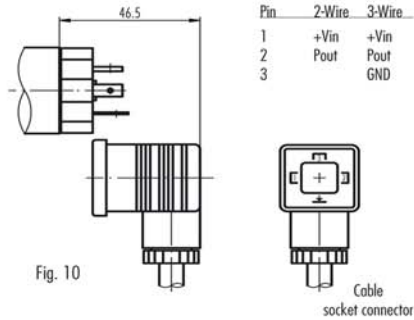

Fig. 10

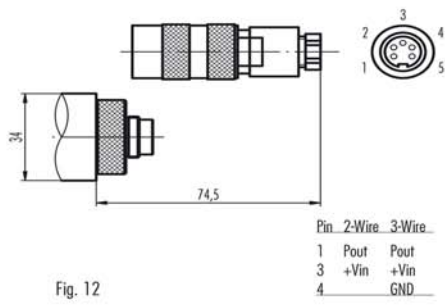

Fig. 12

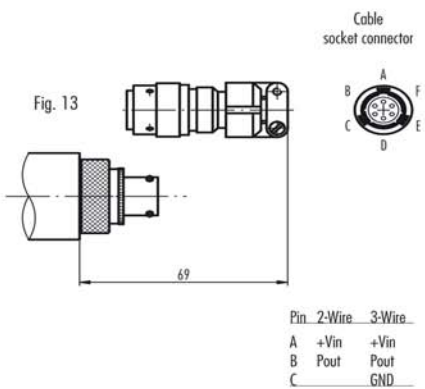

Fig. 13

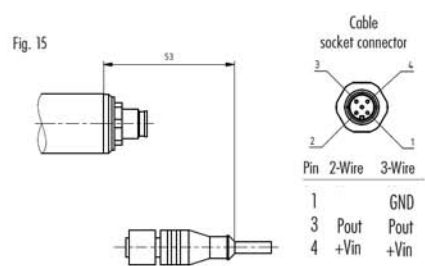

Fig. 15

Specifications may change without notice.

STS Headquarters, Switzerland:
STS Sensor Technik Sirmach AG
Rüthofstrasse 8, 8370 Sirmach, Switzerland
sales@stssensors.com | www.stssensors.com

STS France:
STS France
844 Route de la Caille, 74350 Allonzier la Caille, France
info-fr@stssensors.com | www.stssensors.fr

STS Germany:
STS Sensoren Transmitter Systeme GmbH
Poststrasse 7, 71063 Sindelfingen, Germany
info-de@stssensors.com | www.stssensors.de

STS Great Britain:
STS Great Britain Ltd.
Box 3942 | Warwick | CV34 9AE, United Kingdom
contact@stssensors.com | www.stssensors.co.uk

STS Italy:
STS Italia s.r.l.
Via Gesù 5, 20090 Opera (Milano), Italy
info-italia@stssensors.com | www.stssensors.it