

Pressure Transmitter - ATEX certified

PTM/Ex - Programmable Transmitter



Customer benefits

- Certificate: ATEX & EAC
- High flexibility due to scalable pressure range
- Adjustment of zero and span setting through software commands in the field
- Fast customization thanks to configurable product design
- Stainless steel and titanium version for use in acidic or otherwise aggressive media

Version: 03.05.2016

Technical Specifications

Pressure measuring range (bar)

	0.1 ... 0.5	> 0.5 ... 2	> 2 ... 25
Overpressure	3 bar	3 x FS (≥ 3 bar)	3 x FS
Burst pressure, (4)	> 200 bar	> 200 bar	> 200 bar
Accuracy, (5), (\pm % FS)	≤ 0.25	≤ 0.1	≤ 0.1
Total Error, (6), (7), (\pm % FS)			
-10 ... 50°C, (typ. / max.)	$\leq 0.15 / 0.3$ (≤ 200 mbar: 0.3 / 0.6)	$\leq 0.15 / 0.3$	$\leq 0.15 / 0.3$
-25 ... 85°C, (typ. / max.)	$\leq 0.65 / 0.7$ (≤ 200 mbar: 0.65 / 0.8)	$\leq 0.65 / 0.7$	$\leq 0.55 / 0.7$
Long term stability, (8)	< 0.5% FS / < 4 mbar	< 0.2% FS / < 4 mbar	< 0.1% FS / < 0.2% FS

	> 25 ... 600, (1), (2), (3)	> 600 ... 1000, (1)
Overpressure	3 x FS ($\leq 850 / \leq 1500$ bar)	1500 bar
Burst pressure, (4)	> 850 / ≤ 1500 bar	> 1500 bar
Accuracy, (5), (\pm % FS)	≤ 0.1	≤ 0.25
Total Error, (6), (7), (\pm % FS)		
-10 ... 50°C, (typ. / max.)	$\leq 0.15 / 0.3$	n.a.
-25 ... 85°C, (typ. / max.)	$\leq 0.55 / 0.7$	n.a.
Long term stability, (8)	< 0.1% FS / < 0.2% FS	< 0.1% FS / < 0.2% FS

- (1) Titanium available ≤ 400 bar (burst pressure > 550 bar)
 (2) Process connection frontal and flush diaphragm available ≤ 600 bar
 (3) Overpressure and burst pressure 1500 bar (stainless steel) optional
 (4) Transducer
 (5) Zero based accuracy according to DIN-16086, incl. hysteresis and repeatability at ambient temperature
 (6) Total error including accuracy and temperature influences at maximum signal span (16 mA)
 (7) Active compensated, ≤ 100 bar
 (8) 1 year (typ. / max.), the long term stability can be improved by ageing (burn-in) the sensor

Temperature range

Operating temperature	-25 ... 85°C
Process temperature	-40 ... 150°C
Storage temperature	-25 ... 85°C

Electrical specifications

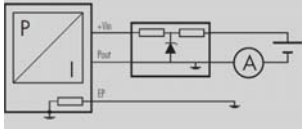
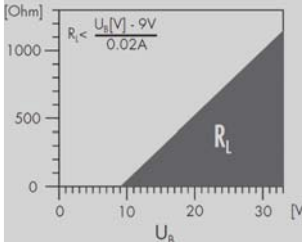
	4 ... 20 mA
Resolution	0.025% FS
Output adjustable	
4 mA	-5% FS ... 105% FS
20 mA	-5% FS ... 105% FS
Span	25% FS ... 110% FS (≥ 100 mbar)
Low pass filter	0.1 / 1 / 10 / 30 Hz (standard: 30 Hz)
Power supply	9 ... 28 VDC
Supply influence	< 0.1% FS
Circuit diagram	
Load resistance	
Load influence	< 0.1% FS

ATEX Approval

Certificate, (1)	SEV 08 ATEX 0142		
Gas	II 1G Ex ia IIC T3 ... T6	EN 60079-0 / -11 / -26	
Dust	II 1D Ex ia IIIC IP6x T80°C ... T125°C	EN 61241-0 / -11	
Temperature class, (2)	T6	T4	T3
Ambient temperature	-25 ... 55°C	-25 ... 85°C	-25 ... 85°C
Process temperature	-25 ... 55°C	-25 ... 100°C	-25 ... 150°C
Maximum values of the connection circuit	28 V / 93 mA / 0.65 W		

(1) For detailed Ex specifications see certificate and operating an safety instructions

(2) Without any information about temperature class the transmitter will be delivered for T4

GL Approval

Certificate	60332-09 HH
Field of application	D, F, EMC1

Additional approvals

DNV	A-11280
ABS	09-HG436727/1-PDA

Qualifications

	Description	Level	Typical interferences
EN 60068-2-6	Vibration	4g (4 ... 100 Hz / \pm 3.2 mmp)	
EN 60068-2-27	Shock	100g (impulse duration 6 ms)	
EN 55022	Emission, class B	< 30 dB μ V/m (0.03 ... 1 GHz)	
EN 61000-4-2	Electrostatic discharge	8 kV contact 15 kV air	
EN 61000-4-3	Irradiated RF	10V/m (0.08 ... 2.7 GHz, 3s)	Radio sets, wireless phones
EN 61000-4-4	Transients (burst)	4 kV	Motors, valves
EN 61000-4-5	Surge	Line-Line: 0.5 kV/42 Ω Line-Earth: 1 kV/42 Ω	Overvoltage
EN 61000-4-6	Conducted RF	10 V (0.15 ... 80 MHz, 3 s)	Frequency converters

Physical specifications

Materials	
Transducer	Stainless steel (316L / 1.4435), titanium (Gr. 2), (1)
Housing	Stainless steel (316L / 1.4404), titanium (Gr. 2)
Seals	Viton (standard), EPDM, Kalrez, NBR
Cable	PUR, FEP

(1) Hastelloy (C-276) on request

Equipment

Overview

10.00.0091	Accessories overview

Interface

102442	PTM/Ex - Interface

Software

101224	PC Software V1.50

Additional documents

Manuals

	Article number	Description
10.00.0079	DEB003	Configuration software
10.00.0089	DEB005	User manual

Operating and safety instructions

	Article number
10.00.0271	DMM023

Ordering information

		X. XXXX.	XXXX.	XX.	XXX
Type					
	PTM/Ex	47			
Pressure type					
	Gauge	1			
	Absolute (vacuum)	2			
	Sealed gauge	3			
Pressure measuring range					
	100 mbar ... 600 bar	XX			
	> 600 bar	XX			
	Negative ranges, offset, special adjustment	99			
Process connection					
	G 1/4 F (Fig. 1)	00			
	1/4 NPT M (Fig. 7)	10			
	1/2 NPT M (Fig. 6)	19			
	G 1/4 M (Fig. 2)	11			
	G1/4 flush diaphragm	21			
	G 1/4 M, manometer DIN 16288	12			
	G 1/2 M (Fig. 3)	13			
	G1/2 M Hastelloy C276	98			
	G 1/2 M, frontal diaphragm (Fig. 4), (3)	14			
	G1/2 M, frontal diaphragm Hastelloy C276	37			
	G 1/2 M, flush diaphragm (Fig. 5), (3)	15			
	G 1/2 M, manometer DIN 16288	16			
	G 1/2 male with bore Ø 14 mm	17			
	Customized	99			
Electrical connection					
	DIN-43650, with metal threaded part, demountable, IP 65 (Fig. 10), (4)		01		
	M16 (Binder 723), 5 pins, IP 67, (Fig. 11), (4)		03		
	M16 (Binder 723), 7 pins, demountable, IP 67, (Fig. 11), (4)		04		
	MIL C26482, 10-6, IP 40 (Fig. 13), (4)		06		
	M12 (Lumberg RSF4), 4 pins (Fig. 15), (4)		07		
	PUR cable, blue, IP 67, (Fig. 12), (5), (6)		17		
	FEP cable, blue, IP 67, (Fig. 12), (5)		22		
	PUR cable, blue, with submersible back end IP68		99		
	Customized				
Output signal					
	4 ... 20 mA		05		
	4 ... 20 mA with overvoltage protection		08		
Accuracy					
	≤ ± 0.25% FS (≤ 500 mbar / > 600 bar)			1	
	≤ ± 0.1% FS (> 500 mbar ... 600 bar)			2	
Temperature range					
	T6 (Ta: -25 ... 55°C) 0 ... 70°C compensated (allowed process temperature: -25 ... 55°C)			0	
	T4 (Ta: -25 ... 85°C) -25 ... 85°C compensated (allowed process temperature: -25 ... 100°C)			1	
	T3 (Ta: -25 ... 85°C) -25 ... 85°C compensated (allowed process temperature: -25 ... 150°C)			2	
Option 1					
	Throttle, (7)				A
	Special oil filling: Anderol Food (for food applications)				G

Special oil filling: PAO4 (silikone free)					Q
Option 2					
Option 3					
Active compensated (≥ 100 mbar ≤ 100 bar)					E
Version titanium					K
Seals: Viton (standard)					U
Seals: EPDM					S
Seals: Kalrez					T
Seals: NBR (ACS)					H

- (3) Process connection available ≤ 600 bar
- (4) Cable socket connector not included
- (5) Please specify the required cable length and medium
- (6) For operating temperature $> 50^{\circ}\text{C}$, FEP cable must be used
- (7) Only with pressure connection Fig. 2, Fig. 3, Fig. 6 and Fig. 7

Technical drawings

Pressure connections

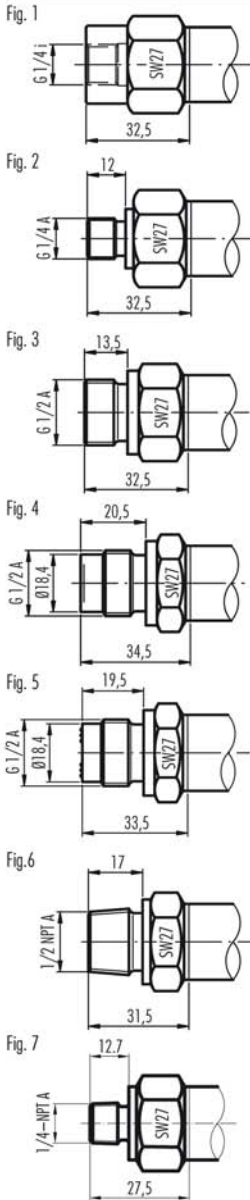

Dimensions

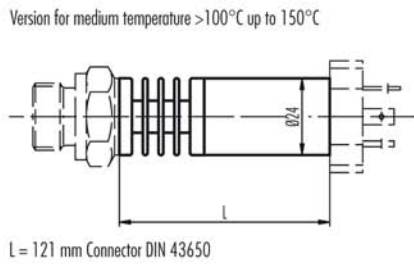
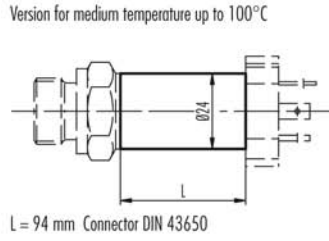

Electrical connections

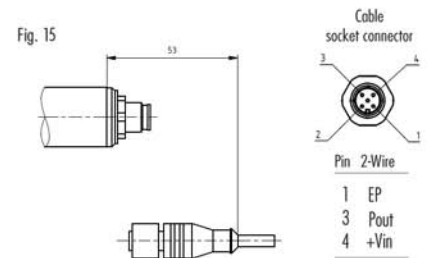
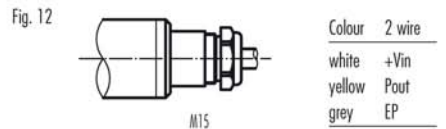
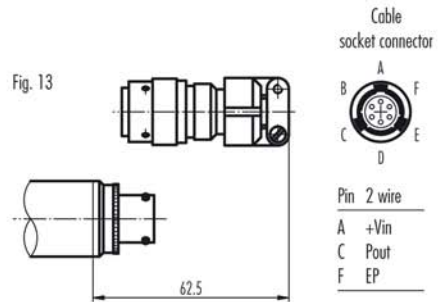
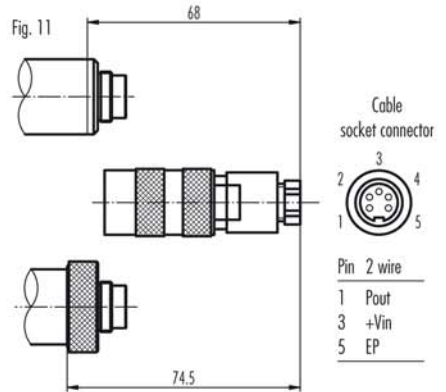
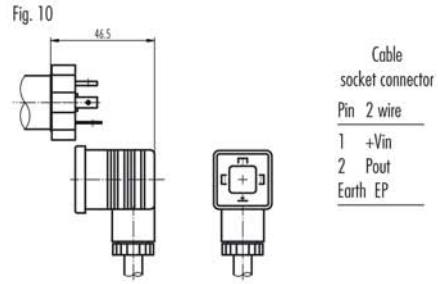

Specifications may change without notice.

STS Headquarters, Switzerland:
STS Sensor Technik Sirmach AG
Rüthofstrasse 8, 8370 Sirmach, Switzerland
sales@stssensors.com | www.stssensors.com

STS France:
STS France
844 Route de la Caille, 74350 Allonzier la Caille, France
info-fr@stssensors.com | www.stssensors.fr

STS Germany:
STS Sensoren Transmitter Systeme GmbH
Poststrasse 7, 71063 Sindelfingen, Germany
info-de@stssensors.com | www.stssensors.de

STS Great Britain:
STS Great Britain Ltd.
Box 3942 | Warwick | CV34 9AE, United Kingdom
contact@stssensors.com | www.stssensors.co.uk

STS Italy:
STS Italia s.r.l.
Via Gesù 5, 20090 Opera (Milano), Italy
info-italia@stssensors.com | www.stssensors.it