

POSIWIRE[®]

Cable Extension Position Sensors

WS100M
Position Sensor

Datasheet



Copyright

© ASM GmbH
Am Bleichbach 18-24
85452 Moosinning
Germany

The information presented in this data sheet does not form part of any quotation or contract, is believed to be accurate and reliable and may be changed without notice. No liability will be accepted by ASM for any consequence of its use. Publication thereof does not convey nor imply any license under patent or industrial or intellectual property rights. Applications that are described herein for any of these products are for illustrative purpose only.

ASM makes no representation or warranty that such applications will be suitable for the specified use without further testing or modification.

Analog output	4
Specifications	4
Order code	5
Magnetic encoder, analog output	6
Specifications	6
Order code	7
Magnetic encoder, analog output, programmable	8
Specifications	8
Order code	9
Magnetic encoder, analog output, redundant.....	10
Specifications	10
Order code	11
Digital output SSI.....	12
Specifications	12
Order code	13
Magnetic encoder, digital output CAN Bus.....	14
Specifications	14
Order code	15
Dimensions	16
Measurement range 2000 ... 3500 mm, analog output, SSI output, magnetic encoder output	16
Measurement range 7500 mm, analog output, SSI output, magnetic encoder output	17
Measurement range 10000 mm, analog output, SSI output, magnetic encoder output	18
Output specifications	19
Analog outputs	19
Voltage divider R1K.....	19
Signal conditioner 10V and 10V5	20
Signal conditioner 420A	21
Signal conditioner 420T.....	22
Magnetic encoder, analog output.....	23
Magnetic encoder, analog output, programmable	25
Magnetic encoder, analog output, redundant	27
Magnetic encoder, digital output SSI	29
Magnetic encoder, digital output CANopen	31
Magnetic encoder, digital output CAN SAE J1939	32

Analog output

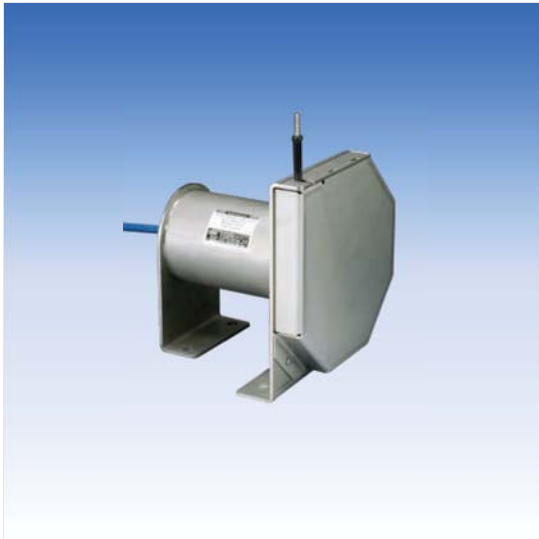

Sensor features

- Measurement range up to 10000 mm
- Protection class IP68/IP69
- Analog output

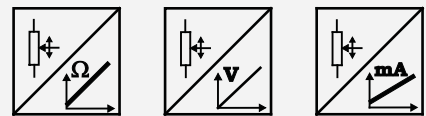

Specifications

Output	R1K 10V 420A 420T	= Potentiometer 1 kΩ = Voltage 0 ... 10 V = Current 4 ... 20 mA, 2 wire = Current 4 ... 20 mA, 3 wire
Resolution	Quasi infinite	
Linearity	±0.10% f.s. (standard) ±0.05% f.s. (optional)	
Sensing device	Precision potentiometer	
Housing material	Stainless steel measuring cable: stainless steel	
Protection class	IP68/IP69	
Connection	Cable output, standard length 2 m	
Temperature range	-20 ... +85 °C	
Weight	2000 mm: 3500 mm: 7500 mm: 10000 mm:	4.5 kg 4.6 kg 5.6 kg 6.8 kg
EMC	DIN EN 61326-1:2013	

Order code

WS100M – 1 – 2 – 3 – 4 – 5

1 Measurement range (in mm)

2000 / 3500 / 7500 / 10000

2 Output

R1K = Potentiometer 1 kΩ
10V = Voltage 0 ... 10 V
420A = Current 4 ... 20 mA, 2 wire
420T = Current 4 ... 20 mA, 3 wire

3 Linearity

L10 = ±0.10% f.s. (standard)
L05 = ±0.05% f.s. (optional)

4 Cable fixing

M4VA = M4 cable fixing

5 Connection

KAB2M = Cable output, standard length 2 m

Order example

WS100M – 7500 – 420T – L10 – M4VA – KAB2M

Magnetic encoder, analog output

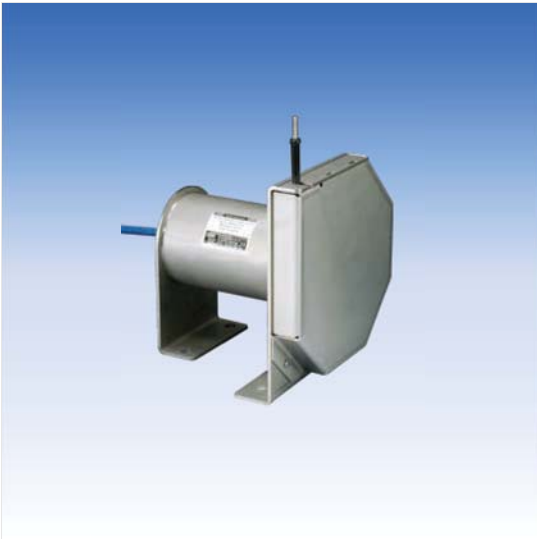

Sensor features

- With magnetic absolute encoder
- Measurement range up to 10000 mm
- Protection class IP68/IP69
- Analog output
- Absolute measurement

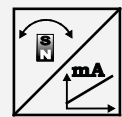
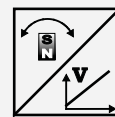

Specifications

Output	U2 U8 I1	= Voltage 0.5 ... 10 V = Voltage 0.5 ... 4.5 V = Current 4 ... 20 mA, 3 wire
Resolution	<0.002% f.s.	
Linearity	±0.10% f.s. (standard) ±0.05% f.s. (optional)	
Sensing device	Magnetic absolute encoder	
Housing material	Stainless steel measuring cable: stainless steel	
Protection class	IP68/IP69	
Connection	Cable output, standard length 2 m	
Shock	DIN EN 60068-2-27:2010, 100 g/11 ms, 100 shocks	
Vibration	DIN EN 60068-2-6:2008, 20 g 10 Hz-2 kHz, 10 cycles	
Temperature range	-20 ... +85 °C	
Weight	2000 mm: 3500 mm: 7500 mm: 10000 mm:	4.5 kg 4.6 kg 5.6 kg 6.8 kg
EMC	DIN EN 61326-1:2013	

Order code

WS100M – 1 – 2 – 3 – 4 – 5 – 6

1 Measurement range (in mm)

2000 / 3500 / 7500 / 10000

2 Output

U2 = Voltage 0.5 ... 10 V
U8 = Voltage 0.5 ... 4.5 V
I1 = Current 4 ... 20 mA, 3 wire

3 Signal characteristics

A = increasing signal (e.g. 4 ... 20 mA)
D = decreasing signal (e.g. 20 ... 4 mA)

4 Linearity

L10 = ±0.10% f.s. (standard)
L05 = ±0.05% f.s. (optional)

5 Cable fixing

M4VA = M4 cable fixing

6 Connection

KAB2M = Cable output, standard length 2 m

Order example

WS100M – 7500 – U2 – A – L10 – M4VA – KAB2M

Magnetic encoder, analog output, programmable

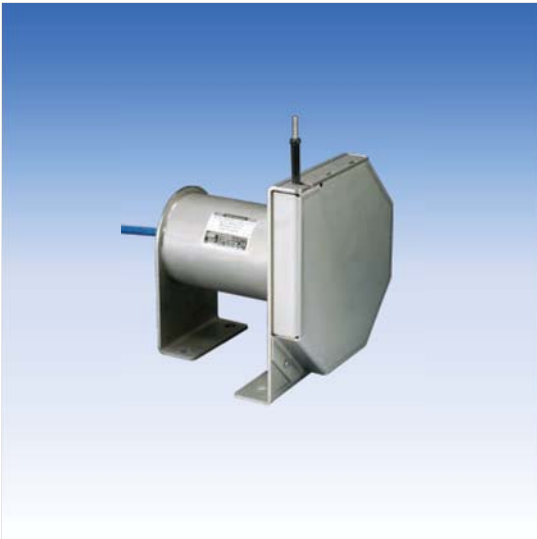

Sensor features

- With magnetic absolute encoder
- Measurement range up to 10000 mm
- Protection class IP68/IP69
- Analog output, programmable
- Absolute measurement

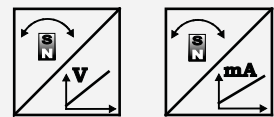

Specifications

Output	U2/PMU = Voltage 0.5 ... 10 V, programmable U8/PMU = Voltage 0.5 ... 4.5 V, programmable I1/PMU = Current 4 ... 20 mA, 3 wire, programmable
Resolution	<0.002% f.s.
Linearity	±0.10% f.s. (standard) ±0.05% f.s. (optional)
Sensing device	Magnetic absolute encoder
Housing material	Stainless steel measuring cable: stainless steel
Protection class	IP68/IP69
Connection	Cable output, standard length 2 m
Shock	DIN EN 60068-2-27:2010, 100 g/11 ms, 100 shocks
Vibration	DIN EN 60068-2-6:2008, 20 g 10 Hz-2 kHz, 10 cycles
Temperature range	-20 ... +85 °C
Weight	2000 mm: 4.5 kg 3500 mm: 4.6 kg 7500 mm: 5.6 kg 10000 mm: 6.8 kg
EMC	DIN EN 61326-1:2013

Order code

WS100M – 1 – 2 – 3 – 4 – 5 – 6

1 Measurement range (in mm)

2000 / 3500 / 7500 / 10000

2 Output

U2/PMU = Voltage 0.5 ... 10 V, programmable
U8/PMU = Voltage 0.5 ... 4.5 V, programmable
I1/PMU = Current 4 ... 20 mA, 3 wire, programmable

3 Signal characteristics

A = increasing signal (e.g. 4 ... 20 mA)
D = decreasing signal (e.g. 20 ... 4 mA)

4 Linearity

L10 = ±0.10% f.s. (standard)
L05 = ±0.05% f.s. (optional)

5 Cable fixing

M4VA = M4 cable fixing

6 Connection

KAB2M = Cable output, standard length 2 m

Order example

WS100M – 7500 – U2/PMU – A – L10 – M4VA – KAB2M

Magnetic encoder, analog output, redundant

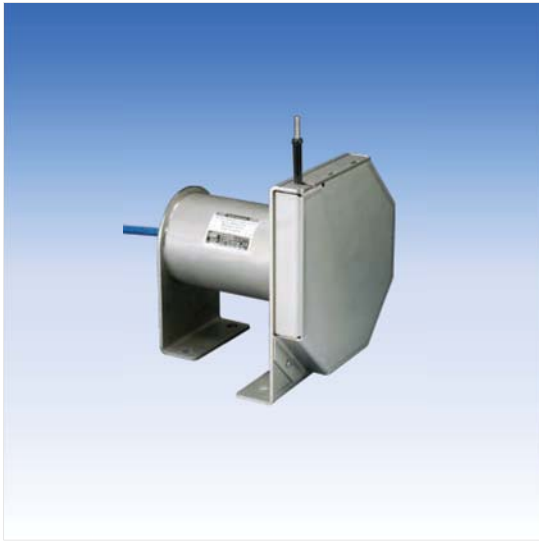

Sensor features

- With magnetic absolute encoder
- Measurement range up to 10000 mm
- Protection class IP68/IP69
- Analog output, redundant
- Absolute measurement

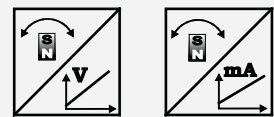

Specifications

Output	U2R U8R I1R	= Voltage 0.5 ... 10 V, redundant = Voltage 0.5 ... 4.5 V, redundant = Current 4 ... 20 mA, 3 wire, redundant
Resolution	<0.002% f.s.	
Linearity	±0.10% f.s. (standard) ±0.05% f.s. (optional)	
Sensing device	Magnetic absolute encoder	
Housing material	Stainless steel measuring cable: stainless steel	
Protection class	IP68/IP69	
Connection	Cable output, standard length 2 m	
Shock	DIN EN 60068-2-27:2010, 100 g/11 ms, 100 shocks	
Vibration	DIN EN 60068-2-6:2008, 20 g 10 Hz-2 kHz, 10 cycles	
Temperature range	-20 ... +85 °C	
Weight	2000 mm: 3500 mm: 7500 mm: 10000 mm:	4.5 kg 4.6 kg 5.6 kg 6.8 kg
EMC	DIN EN 61326-1:2013	

Order code

WS100M – 1 – 2 – 3 – 4 – 5 – 6

1 Measurement range (in mm)

2000 / 3500 / 7500 / 10000

2 Output

U2R = Voltage 0.5 ... 10 V, redundant
U8R = Voltage 0.5 ... 4.5 V, redundant
I1R = Current 4 ... 20 mA, 3 wire, redundant

3 Signal characteristics

A/A = Output 1 increasing, output 2 increasing
A/D = Output 1 increasing, output 2 decreasing
D/D = Output 1 decreasing, output 2 decreasing

4 Linearity

L10 = ±0.10% f.s. (standard)
L05 = ±0.05% f.s. (optional)

5 Cable fixing

M4VA = M4 cable fixing

6 Connection

KAB2M = Cable output, standard length 2 m

Order example

WS100M – 7500 – I1R – A/D – L10 – M4VA – KAB2M

Digital output SSI

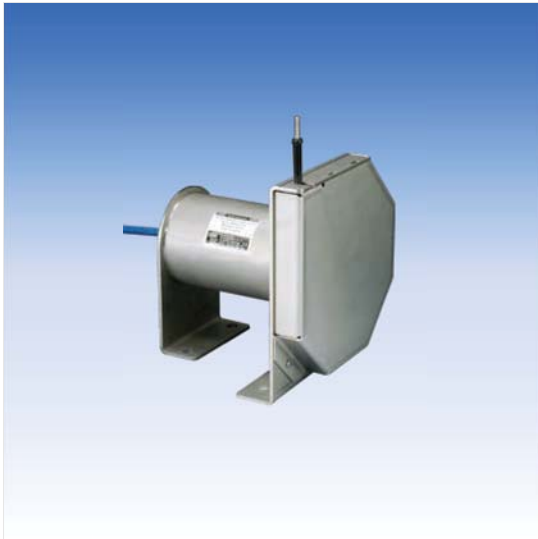

Sensor features

- With magnetic absolute encoder
- Measurement range up to 10000 mm
- Protection class IP68/IP69
- Digital output SSI
- Absolute measurement



Specifications

Output	MSSI = SSI synchronous serial interface
Resolution	50
Linearity	±0.10% f.s. (standard) ±0.05% f.s. (optional)
Sensing device	Magnetic absolute encoder
Housing material	Stainless steel measuring cable: stainless steel
Protection class	IP68/IP69
Connection	Cable output, standard length 2 m
Shock	DIN EN 60068-2-27:2010, 100 g/11 ms, 100 shocks
Vibration	DIN EN 60068-2-6:2008, 20 g 10 Hz-2 kHz, 10 cycles
Temperature range	-20 ... +85 °C
Weight	2000 mm: 4.5 kg 3500 mm: 4.6 kg 7500 mm: 5.6 kg 10000 mm: 6.8 kg
EMC	DIN EN 61326-1:2013

Order code

WS100M – 1 – 2 – 3 – 4 – 5 – 6

1 Measurement range (in mm)

2000 / 3500 / 7500 / 10000

2 Resolution (in µm)

50

3 Output

MSSI = SSI synchronous serial interface

4 Linearity

L10 = ±0.10% f.s. (standard)

L05 = ±0.05% f.s. (optional)

5 Cable fixing

M4VA = M4 cable fixing

6 Connection

KAB2M = Cable output, standard length 2 m

Order example

WS100M – 7500 – 50 – MSSI – L10 – M4VA – KAB2M

Magnetic encoder, digital output CAN Bus



Sensor features

- With magnetic absolute encoder
- Measurement range up to 10000 mm
- Protection class IP68/IP69
- Digital output CAN
- Absolute measurement
- Optional redundant CAN Bus



Specifications

Output	MCANOP = CANopen MCANJ1939 = CAN SAE J1939 MCANOPR = CANopen redundant MCANJ1939R = CAN SAE J1939 redundant
Resolution	setting via CAN Bus
Linearity	±0.10% f.s. (standard) ±0.05% f.s. (optional)
Sensing device	Magnetic absolute encoder
Housing material	Stainless steel measuring cable: stainless steel
Protection class	IP68/IP69
Connection	Cable output, standard length 2 m
Temperature range	-20 ... +85 °C
Weight	2000 mm: 4.5 kg 3500 mm: 4.6 kg 7500 mm: 5.6 kg 10000 mm: 6.8 kg
EMC	DIN EN 61326-1:2013

Order code

WS100M – 1 – 2 – 3 – 4 – 5

1 Measurement range (in mm)

2000 / 3500 / 7500 / 10000

2 Output

MCANOP = CANopen
MCANJ1939 = CAN SAE J1939
MCANOPR = CANopen redundant
MCANJ1939R = CAN SAE J1939 redundant

3 Linearity

L10 = ±0.10% f.s. (standard)
L05 = ±0.05% f.s. (optional)

4 Cable fixing

M4VA = M4 cable fixing

5 Connection

KAB2M = Cable output, standard length 2 m

Order example

WS100M – 7500 – MCANOP – L10 – M4VA – KAB2M

Dimensions

Measurement range 2000 ... 3500 mm, analog output, SSI output, magnetic encoder output

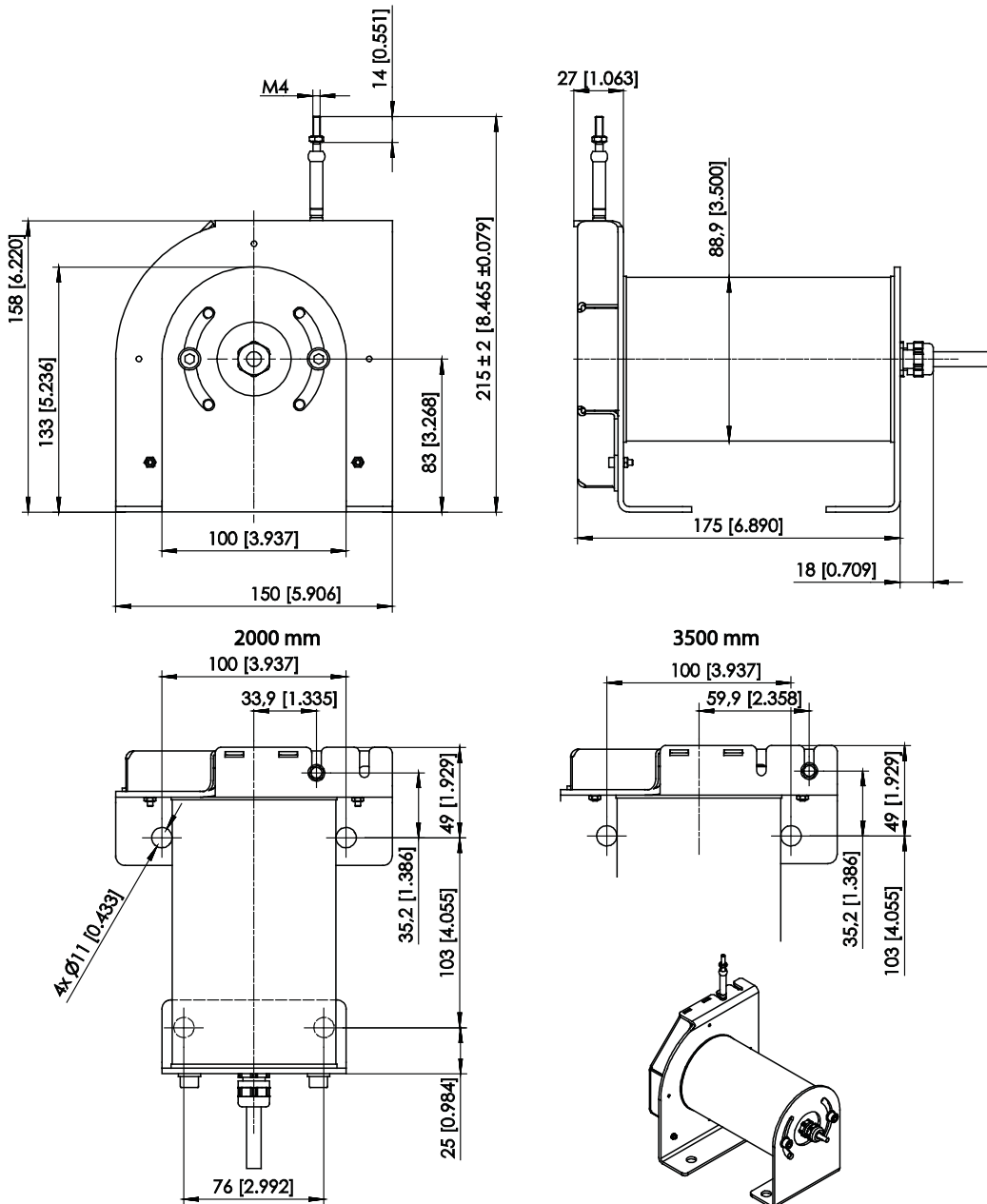

Dimensions in mm [inch]
Dimensions informative only.
For guaranteed dimensions consult factory.

Measurement range 7500 mm, analog output, SSI output, magnetic encoder output

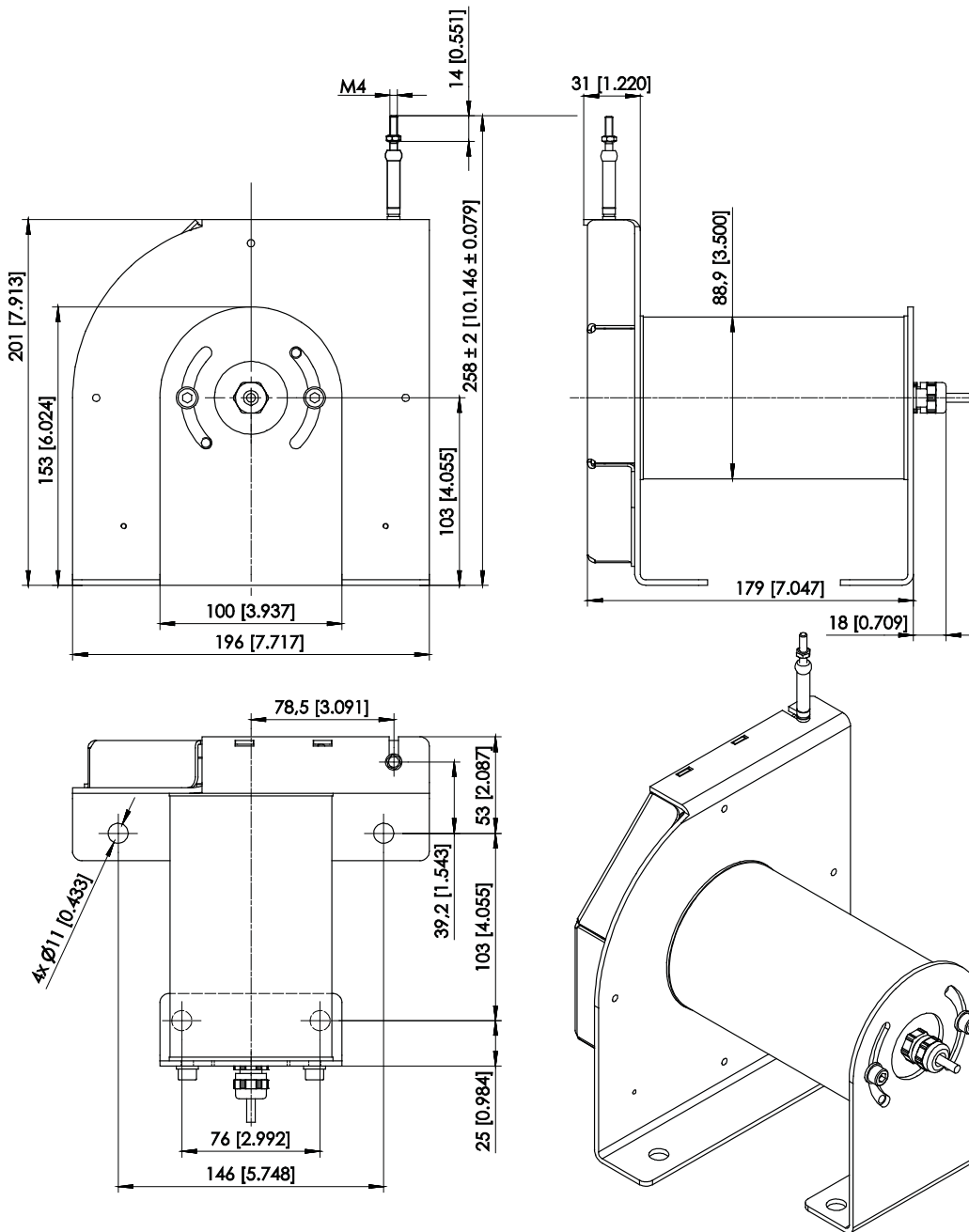

Dimensions in mm [inch]
Dimensions informative only.
For guaranteed dimensions consult factory.

Measurement range 10000 mm, analog output, SSI output, magnetic encoder output

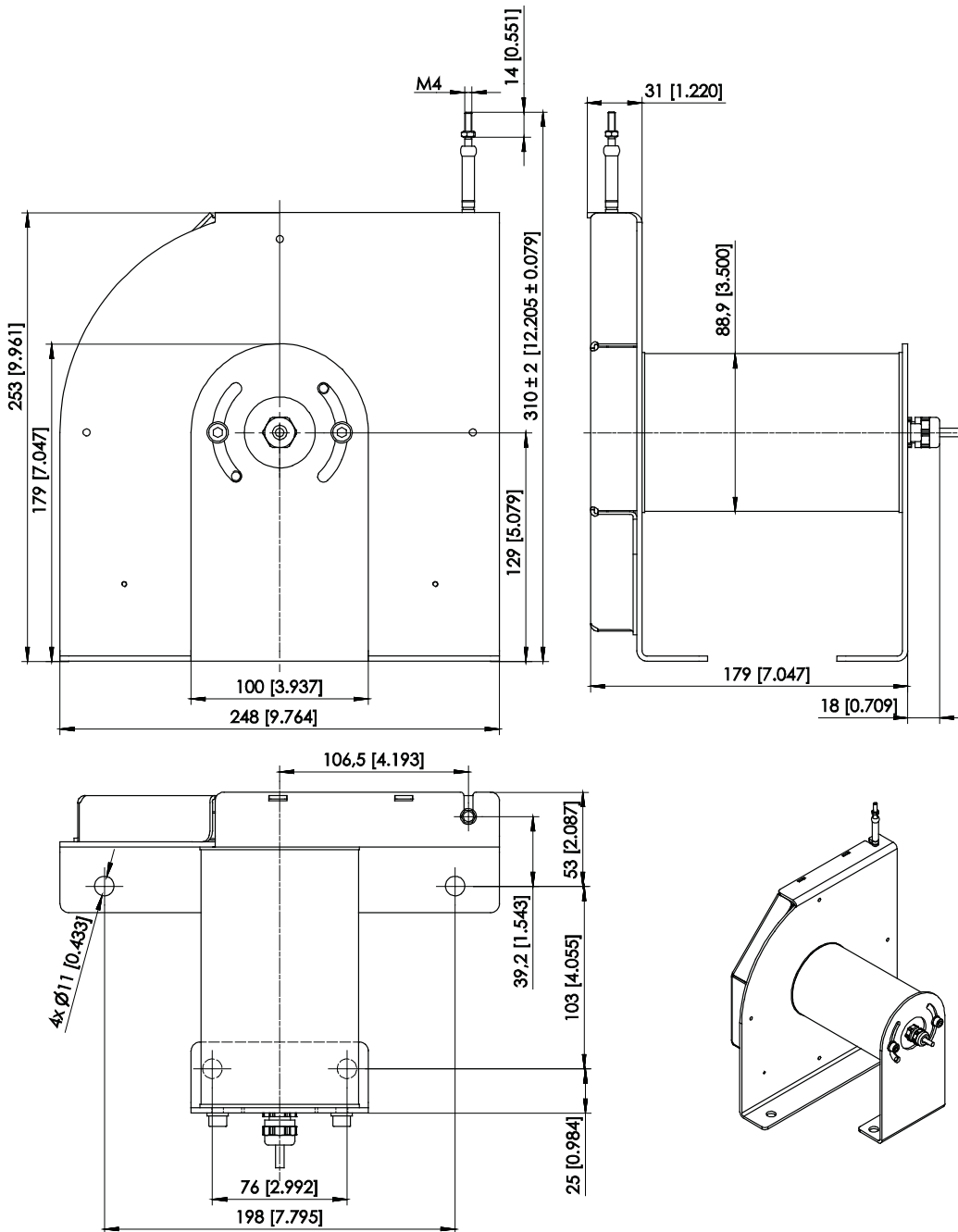

Dimensions in mm [inch]
 Dimensions informative only.
 For guaranteed dimensions consult factory.

Output specifications

Analog outputs

Voltage divider R1K

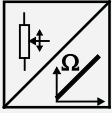
	Excitation voltage	32 V DC max. at 1 kΩ (max. power 1 W)
	Potentiometer impedance	1 kΩ ±10 %
	Thermal coefficient	±25 x 10 ⁻⁶ / °C f.s.
	Sensitivity	Depends on the measuring range, individual sensitivity of the sensor is specified on the label
	Voltage divider utilization range	approx. 3 % ... 97 %
	Operating temperature	Refer to output specification
	EMC	DIN EN 61326-1:2013

Output signals

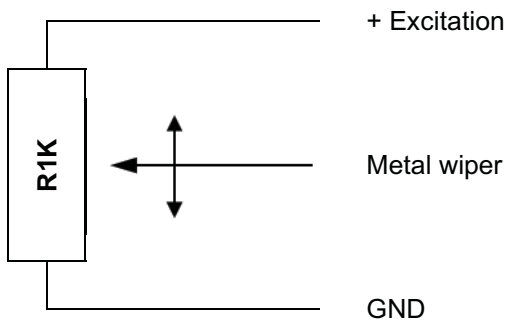

Note:

The metal wiper of the potentiometer must be protected against current load!

Electrical current flow impact on the wiper causes linearity errors and shortens the lifetime of the potentiometer.

Additional information:

http://www.asm-sensor.com/asm/pdf/pro/ws_poti_technote_en.pdf

Signal wiring

Signal	Connector pin no.	Cable color	Cable color
Poti +	1	white	brown
Poti GND	2	brown	white
Poti slider	3	green	blue
-	4	yellow	black
-	5	grey	-
-	6	pink	-
-	7	blue	-
-	8	red	-

View to sensor connector



CONN-M12-8F

Signal conditioner 10V and 10V5

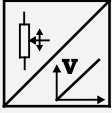
Voltage output 	Excitation voltage	18 ... 27 V DC non stabilized
	Excitation current	20 mA max.
	Output voltage	10V: 0 ... 10 V DC; 10V5: 0.5 ... 10 V DC
	Output current	2 mA max.
	Output load	> 5 kΩ
	Stability (temperature)	$\pm 50 \times 10^{-6} / ^\circ\text{C}$ f.s.
	Protection	Reverse polarity, short circuit
	Output noise	0.5 mV _{RMS}
	Operating temperature	Refer to output specification
	EMC	DIN EN 61326-1:2013

Output signals

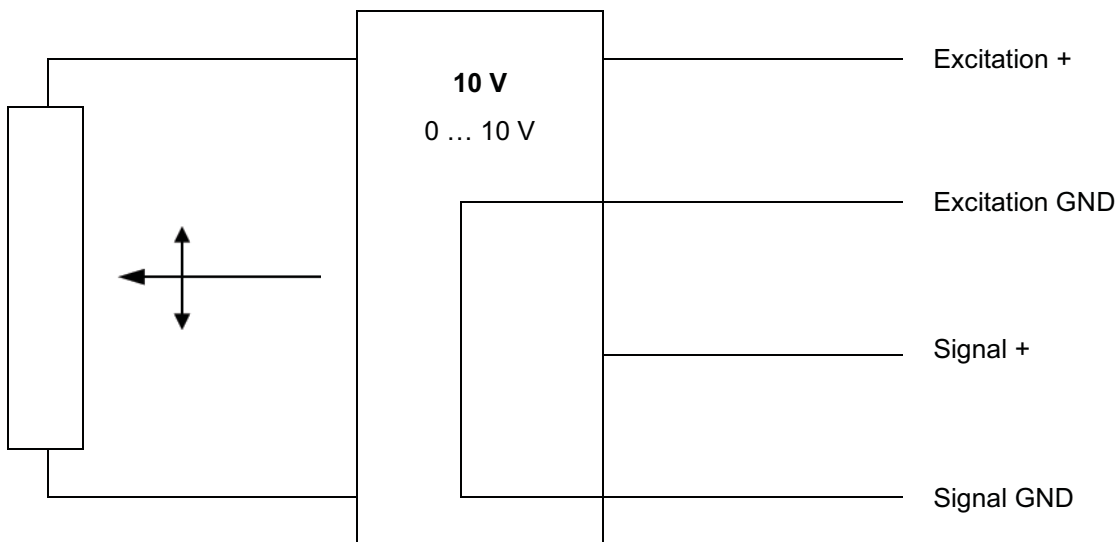

Signal wiring

Signal	Connector pin no.	Cable color	View to sensor connector
Excitation +	1	white	 CONN-M12-8F
Excitation GND	2	brown	
Signal +	3	green	
Signal GND	4	yellow	
Not connected	5	grey	
Not connected	6	pink	
Not connected	7	blue	
Not connected	8	red	

Signal conditioner 420A

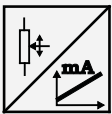
Current output (2 wire) 	Excitation voltage	12 ... 27 V DC non stabilized, measured at the sensor terminals
	Excitation current	35 mA max.
	Output current	4 ... 20 mA equivalent for 0 ... 100 % range
	Stability (temperature)	$\pm 100 \times 10^{-6} / ^\circ\text{C}$ f.s.
	Protection	Reversed polarity, short circuit
	Output noise	0.5 mV _{eff}
	Operating temperature	Refer to output specification
	EMC	DIN EN 61326-1:2013

Output signals

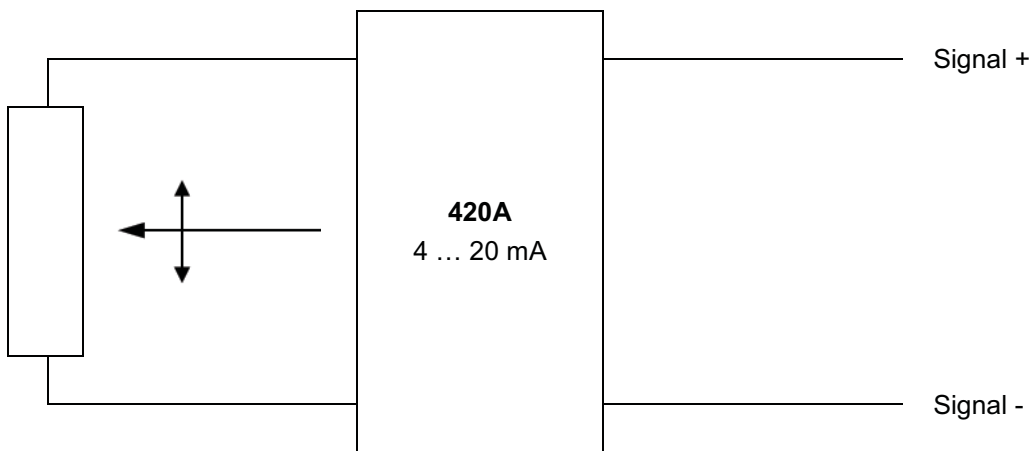

Signal wiring

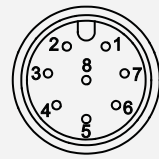
Signal	Connector pin no.	Cable color	View to sensor connector
Signal +	1	white	 CONN-M12-8F
Signal -	2	brown	
Not connected	3	green	
Not connected	4	yellow	
Not connected	5	grey	
Not connected	6	pink	
Not connected	7	blue	
Not connected	8	red	

Signal conditioner 420T

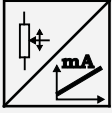
Current output (3 wire) 	Excitation voltage	18 ... 27 V DC non stabilized
	Excitation curren	40 mA max.
	Load resistor	350 Ω max.
	Output current	4 ... 20 mA equivalent for 0 ... 100 % range
	Stability (temperature)	$\pm 50 \times 10^{-6} / ^\circ\text{C}$ f.s.
	Protection	Reverse polarity, short circuit
	Output noise	0.5 mV _{RMS}
	Operating temperature	Refer to output specification
	EMC	DIN EN 61326-1:2013

Output signals

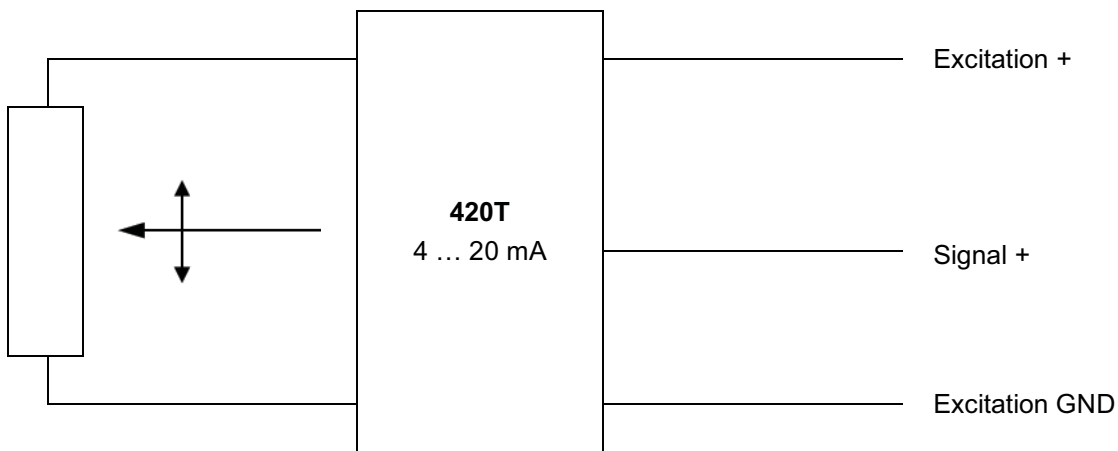

Signal wiring

Signal	Connector pin no.	Cable color	View to sensor connector
Excitation +	1	white	
Excitation GND	2	brown	
Signal +	3	green	
Not connected	4	yellow	
Not connected	5	grey	
Not connected	6	pink	
Not connected	7	blue	
Not connected	8	red	

Magnetic encoder, analog output

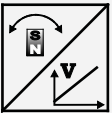
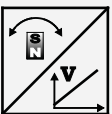
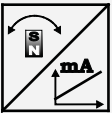
<p>U2</p> <p>Voltage output 0.5 ... 10 V</p> 	Excitation voltage	8 ... 36 V DC
	Excitation current	20 mA typical at 24 V DC 38 mA typical at 12 V DC max. 50 mA
	Output voltage	0.5 ... 10 V DC
	Output current	2 mA max.
	Measuring rate	1 kHz standard
	Stability (temperature)	$\pm 50 \times 10^{-6} / ^\circ\text{C}$ f.s. (typical)
	Protection	Reverse polarity, short circuit
	Operating temperature	See specification of the respective sensor
	EMC	DIN EN 61326-1:2013
<p>U8</p> <p>Voltage output 0.5 ... 4.5 V</p> 	Excitation voltage	8 ... 36 V DC
	Excitation current	17 mA typical at 24 V DC 32 mA typical at 12 V DC 50 mA max.
	Output voltage	0.5 ... 4.5 V DC
	Output current	2 mA max.
	Measuring rate	1 kHz standard
	Stability (temperature)	$\pm 50 \times 10^{-6} / ^\circ\text{C}$ f.s. (typical)
	Protection	Reverse polarity, short circuit
	Operating temperature	See specification of the respective sensor
	EMC	DIN EN 61326-1:2013
<p>I1</p> <p>Current output 4 ... 20 mA, 3 wires</p> 	Excitation voltage	8 ... 36 V DC
	Excitation current	typical 36 mA at 24 V DC typical 70 mA at 12 V DC 120 mA max.
	Load R_L	500 Ω max.
	Output current	4 ... 20 mA
	Measuring rate	1 kHz standard
	Stability (temperature)	$\pm 50 \times 10^{-6} / ^\circ\text{C}$ f.s. (typical)
	Protection	Reverse polarity, short circuit
	Operating temperature	See specification of the respective sensor
	EMC	DIN EN 61326-1:2013

Signal wiring

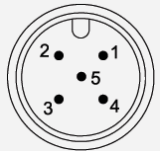
Signal	Connector pin no.	Cable connection	View to the sensor connector
Excitation +	1	brown	
Signal	2	white	
GND	3	blue	
Do not connect!	4	black	
Do not connect!	5	(grey)	

Signal diagram

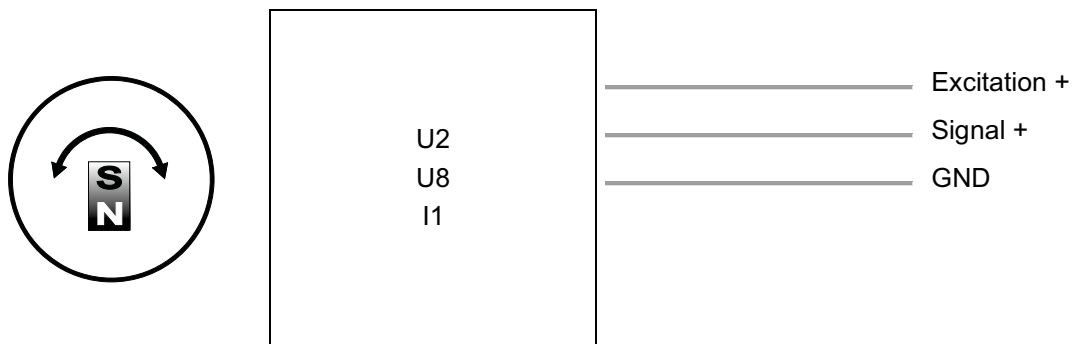

Magnetic encoder, analog output, programmable

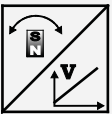
<p>U2/PMU</p> <p>Voltage output 0.5 ... 10 V</p> 	Excitation voltage	8 ... 36 V DC
	Excitation current	20 mA typical at 24 V DC 38 mA typical at 12 V DC max. 50 mA
	Output voltage	0,5 ... 10 V DC
	Output current	2 mA max.
	Measuring rate	1 kHz standard
	Stability (temperature)	$\pm 50 \times 10^{-6} / ^\circ\text{C}$ f.s. (typical)
	Protection	Reverse polarity, short circuit
	Operating temperature	See specification of the respective sensor
	EMC	EN 61326-1:2013

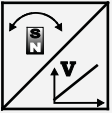
<p>U8/PMU</p> <p>Voltage output 0.5 ... 4.5 V</p> 	Excitation voltage	8 ... 36 V DC
	Excitation current	17 mA typical at 24 V DC 32 mA typical at 12 V DC max. 50 mA
	Output voltage	0.5 ... 4.5 V DC
	Output current	2 mA max.
	Measuring rate	1 kHz standard
	Stabilität (Temperatur)	$\pm 50 \times 10^{-6} / ^\circ\text{C}$ f.s. (typical)
	Protection	Reverse polarity, short circuit
	Operating temperature	See specification of the respective sensor
	EMC	DIN EN 61326-1:2013

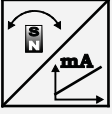
<p>I1/PMU</p> <p>Current output 4 ... 20 mA, 3 wires</p> 	Excitation voltage	8 ... 36 V DC
	Excitation current	typical 36 mA at 24 V DC typical 70 mA at 12 V DC max. 120 mA
	Load R_L	500 Ω max.
	Output current	4 ... 20 mA
	Measuring rate	1 kHz standard
	Stability (temperature)	$\pm 50 \times 10^{-6} / ^\circ\text{C}$ f.s. (typical)
	Protection	Reverse polarity, short circuit
	Operating temperature	See specification of the respective sensor
	EMC	DIN EN 61326-1:2013

Signal wiring

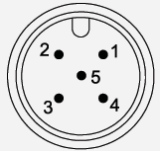
Signal	Connector pin no.	Cable color	View to sensor connector
Excitation +	1	brown	
Signal	2	white	
GND	3	blue	
Do not connect!	4	black	
SPAN/ZERO	5	grey	

Signal diagram

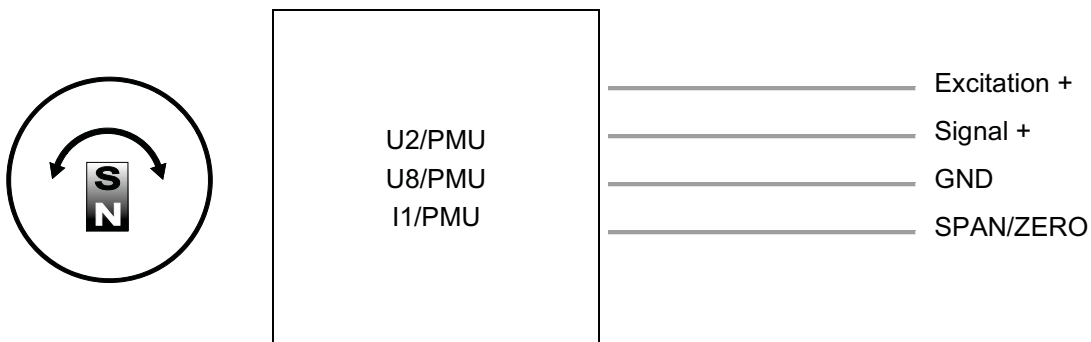

Option -PMU

Programming of the start and end value by the customer

Teach-In of start and end value for the options U2/PMU, I1/PMU, U8/PMU is provided by a binary signal SPAN/ZERO. At the start position connect signal SPAN/ZERO for a period of 2 ... 3 seconds to GND via push button. At the end position connect signal SPAN/ZERO for a period of 5 ... 6 seconds to GND via a push button. The scaling taught in that way will be stored non-volatile.

To reset the sensor to factory default signal ZERO/END must be connected to ground while powering up the sensor for 2 ... 3 seconds. For the option PMZ only teach-in of ZERO position is possible.

Magnetic encoder, analog output, redundant

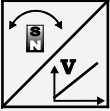
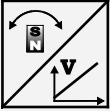
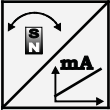
<p>U2R</p> <p>Voltage output 0.5 ... 10 V</p> 	Excitation voltage	8 ... 36 V DC
	Excitation current	20 mA typical at 24 V DC 38 mA typical at 12 V DC max. 50 mA per channel
	Output voltage	0.5 ... 10 V DC
	Output current	2 mA max.
	Measuring rate	1 kHz standard
	Stability (temperature)	$\pm 50 \times 10^{-6} / ^\circ\text{C}$ f.s. (typical)
	Protection	Reverse polarity, short circuit
	Operating temperature	See specification of the respective sensor
	EMC	DIN EN 61326-1:2013
<p>U8R</p> <p>Voltage output 0.5 ... 4.5 V</p> 	Excitation voltage	8 ... 36 V DC
	Excitation current	17 mA typical at 24 V DC 32 mA typical at 12 V DC max. 50 mA per channel
	Output voltage	0.5 ... 4.5 V DC
	Output current	2 mA max.
	Measuring rate	1 kHz standard
	Stability (temperature)	$\pm 50 \times 10^{-6} / ^\circ\text{C}$ f.s. (typical)
	Protection	Reverse polarity, short circuit
	Operating temperature	See specification of the respective sensor
	EMC	DIN EN 61326-1:2013
<p>I1R</p> <p>Current output 4 ... 20 mA, 3 wires</p> 	Excitation voltage	8 ... 36 V DC
	Excitation current	36 mA typical at 24 V DC 76 mA typical at 12 V DC max. 120 mA per channel
	Load R_L	500 Ω max.
	Output current	4 ... 20 mA
	Measuring rate	1 kHz standard
	Stability (temperature)	$\pm 50 \times 10^{-6} / ^\circ\text{C}$ f.s. (typical)
	Protection	Reverse polarity, short circuit
	Operating temperature	See specification of the respective sensor
	EMC	DIN EN 61326-1:2013

Signal wiring

Channel	Signal	Connector pin no.	Cable color	View to the sensor connector
1	Excitation +	1	white	
1	Signal	2	brown	
1	GND	3	green	
1	Do not connect!	4	yellow	
2	Excitation +	5	grey	
2	Signal	6	pink	
2	GND	7	blue	
2	Do not connect!	8	red	

Signal diagram

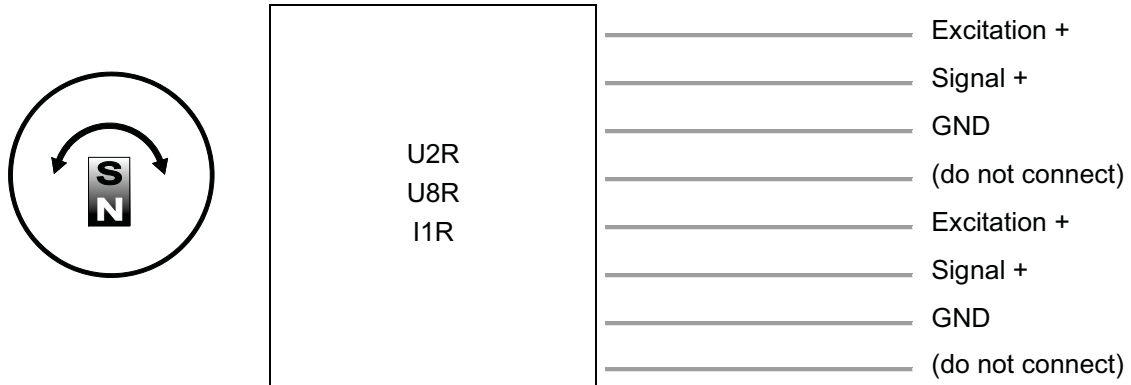

Magnetic encoder, digital output SSI

MSSI Synchronous serial SSI 	Interface	EIA RS-422
	Excitation voltage	8 ... 36 V DC
	Excitation current	19 mA typical at 24 V DC 35 mA typical at 12 V DC max. 80 mA
	Clock frequency	100 kHz ... 500 kHz
	Code	Gray-Code, continuous progression
	Delay between pulse trains (t_p)	30 μ s min.
	Stability (temperature)	$\pm 50 \times 10^{-6} / ^\circ\text{C}$ f.s. (typical)
	Operating temperature	See specification of the respective sensor
	Protection	Reverse polarity, short circuit
	EMC	DIN EN 61326-1:2013

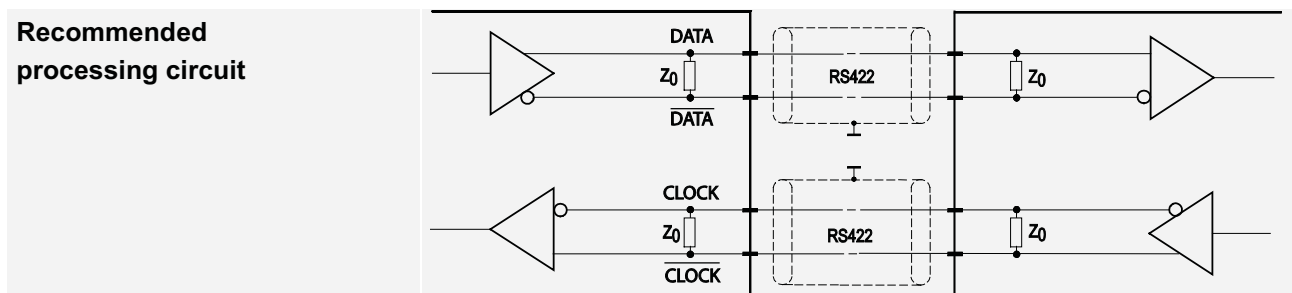
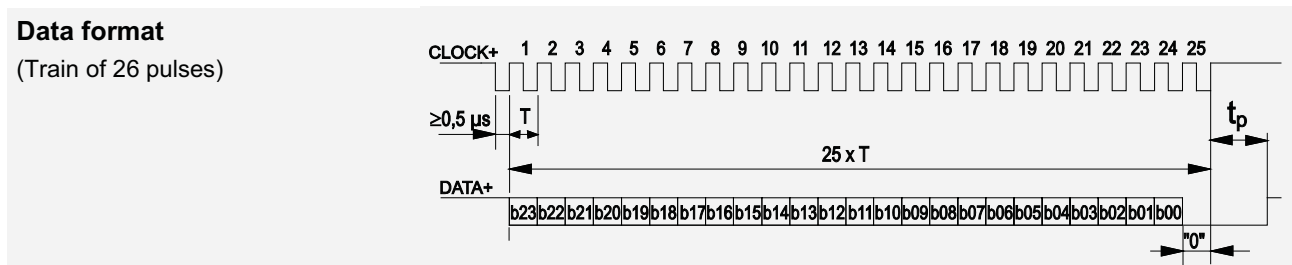

Transmission rate	Cable length	Baud rate
	50 m	100-400 kHz
	100 m	100-300 kHz

Note:
Extension of the cable length will reduce the maximum transmission rate.

Signal wiring

Signal	Connector pin no.	Cable color	View to sensor connector
Excitation +	1	white	
Excitation GND	2	brown	
CLOCK	3	green	
$\overline{\text{CLOCK}}$	4	yellow	
DATA	5	grey	
$\overline{\text{DATA}}$	6	pink	
-	7	blue	
-	8	red	

Magnetic encoder, digital output CANopen

MCANOP, CANOPR CANopen 	CAN specification	ISO 11898, Basic and Full CAN 2.0 B
	Communication profile	CANopen CiA 301 V 4.02, Slave
	Encoder profile	Encoder CiA 406 V 3.2
	Error Control	Node Guarding, Heartbeat, Emergency Message
	Node ID	Adjustable via LSS or SDO, default: 127
	PDO	3 TxPDO, 0 RxPDO, no linking, static mapping
	PDO Modes	Event-/Time triggered, Remote-request, Sync cyclic/acyclic
	SDO	1 Server, 0 Client
	CAM	8 cams
	Certified	Yes
	Transmission rate	50 kBit bis 1 Mbit, adjustable via LSS or SDO, default: 125 kBit
	Bus connection	M12 connector, 5 pin
	Integrated bus terminating resistor	120Ω adjustable by the customer
	Bus, galvanic isolated	no

Specifications	Excitation voltage	8 ... 36 V DC
	Excitation current	20 mA typical at 24 V DC 40 mA typical at 12 V DC 80 mA max.
	Measuring rate	1 kHz (asynchronous)
	Stability (temperature)	$\pm 50 \times 10^{-6}/^{\circ}\text{C}$ f.s. (typical)
	Repeatability	1 LSB
	Operating temperature	See specification of the respective sensor
	Protection	Reverse polarity, short circuit
	Dielectric strength	1 kV (V AC, 50 Hz, 1 min.)
	EMC	EN 61326-1:2013

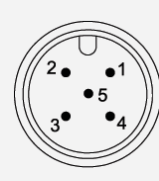
Signal wiring	Signal	Connector pin no.	View to the sensor connector
	Shield	1	
	Excitation +	2	
	GND	3	
	CAN-H	4	
	CAN-L	5	

Magnetic encoder, digital output CAN SAE J1939

MCANJ1939/R CAN SAE J1939 	CAN Specification	ISO 11898, Basic and Full CAN 2.0 B
	Transceiver	24V-compliant, not isolated
	Communication profile	SAE J1939
	Baud Rate	250 kbit/s
	Internal termination resistor	120 Ω adjustable by the customer
	Address	Default 247d, configurable

NAME Fields	Arbitrary address capable	1	Yes
	Industry group	0	Global
	Vehicle system	7Fh (127d)	Non specific
	Vehicle system instance	0	
	Function	FFh (255d)	Non specific
	Function instance	0	
	ECU instance	0	
	Manufacturer	145h (325d)	Manufacturer ID
	Identity number	0nnn	Serial number 21 bit

Parameter Group Numbers (PGN)	Configuration data	PGN EF00h	Proprietary-A (PDU1 peer-to-peer)
	Process data	PGN FFnnh	Proprietary-B (PDU2 broadcast); nn Group Extension (PS) configurable

Specifications	Excitation voltage	8 ... 36 V DC
	Excitation current	20 mA typical at 24 V DC 40 mA typical at 12 V DC, max. 80 mA
	Measuring rate	1 kHz (asynchronous)
	Stability (temperature)	±50 x 10 ⁻⁶ /°C f.s. (typical)
	Repeatability	1 LSB
	Operating temperature	See specification of the respective sensor
	Protection	Reverse polarity, short circuit
	Dielectric strength	1 kV (V AC, 50 Hz, 1 min.)
EMV	EN 61326-1:2013	

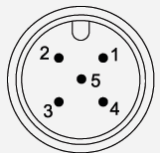
Signal wiring	Signal	Connector pin no.	View to the sensor connector
	Shield	1	
	Excitation +	2	
	GND	3	
	CAN-H	4	
	CAN-L	5	